

IEG1-34804-1A-V

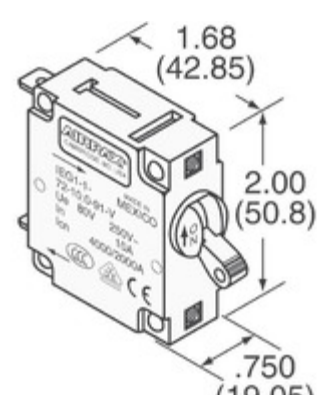

Obrázky jsou pouze orientační.
Podrobné informace o produktu naleznete v části Technické údaje produktu.
Koupit IEG1-34804-1A-V s důvěrou od Component-World.HK, 1 rok záruka



Part Number: [IEG1-34804-1A-V](#)

Výrobce: [Sensata Technologies, Airpax](#)

Popis: CIR BRKR MAG-HYDR LEVER

Datový list: [IEG, IUG, JEG, CEG, LEG Series Datasheet](#)

RoHS Status: Bez olova / V souladu RoHS

Ship From: Hong Kong

Shipment Way: DHL/Fedex/TNT/UPS/EMS

[Request For Quotation](#)







PARAMETR PRODUKTU

Part Number	IEG1-34804-1A-V	Výrobce	Sensata Technologies, Airpax
Popis	CIR BRKR MAG-HYDR LEVER	Stav volného vedení / RoHS	Bez olova / V souladu RoHS
Dostupné množství	2836 pcs	Datový list	IAG,IUG,JEG,CEG,LEG Series Datasheet
Kategorie	Ochrana obvodu	Série	IEG
Počet pólu	1	Typ montáže	Panel Mount
Úroveň citlivosti na vlhkost (MSL)	1 (Unlimited)	Výrobní standardní doba výroby	6 Weeks
Stav volného vedení / RoHS	Lead free / RoHS Compliant	Osvětlení napětí (nominální)	-
Osvětlení	-	Jmenovitá hodnota proudu	-
Breaker Typ	Magnetic (Hydraulic Delay)	Pohon Type	Lever

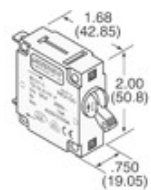
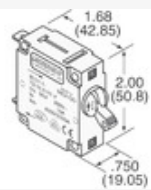
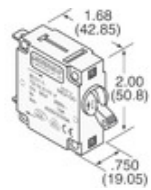
Component-World.com je spolehlivý distributor elektronických součástek. Specializujeme se na všechny elektronické komponenty řady Sensata Technologies, Airpax. Máme 2836 kusy Sensata Technologies, Airpax IEG1-34804-1A-V na skladě dostupných. Vyžádejte si citát z distributora součástí elektroniky na Component-World.com, náš prodejní tým vás bude kontaktovat do 24 hodin.

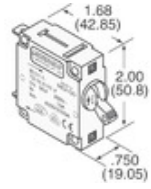
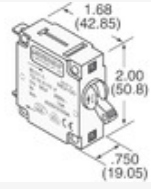
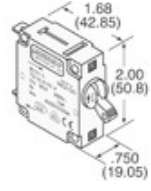
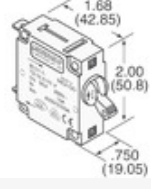
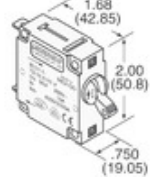
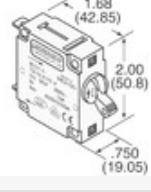
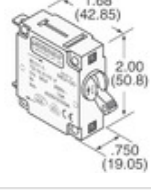
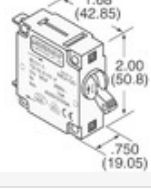
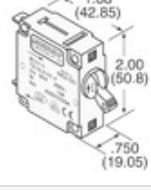
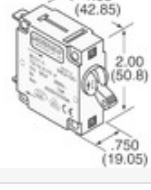
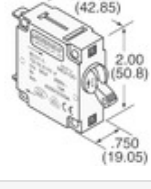
RFQ Email: info@Components-World.com

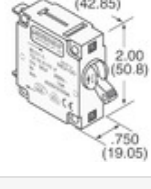
SOUVISEJÍCÍ PRODUKTY

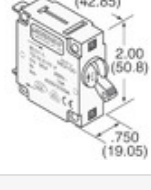
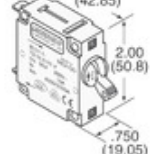
	Část#: IEG1-34863-15-V Výrobci: Sensata Technologies, Airpax	Dotaz
	Část#: IEG1-34467-2-V Výrobci: Sensata Technologies, Airpax	Dotaz
	Část#: IEG1-34919-5-C Výrobci: Sensata Technologies, Airpax	Dotaz
	Část#: IEG1-34411-1-V Výrobci: Sensata Technologies, Airpax	Dotaz
	Část#: IEG1-34804-4A-V Výrobci: Sensata Technologies, Airpax	Dotaz
	Část#: IEG1-34467-5-V Výrobci: Sensata Technologies, Airpax	Dotaz
	Část#: IEG1-34411-3-V Výrobci: Sensata Technologies, Airpax	Dotaz
	Část#: IEG1-34863-20-V Výrobci: Sensata Technologies, Airpax	Dotaz
	Část#: IEG1-34804-3A-V Výrobci: Sensata Technologies, Airpax	Dotaz
	Část#: IEG1-34919-15-C Výrobci: Sensata Technologies, Airpax	Dotaz
	Část#: IEG1-34919-13-C Výrobci: Sensata Technologies, Airpax	Dotaz
	Část#: IEG1-34467-3-V Výrobci: Sensata Technologies, Airpax	Dotaz
	Část#: IEG1-34804-2-V Výrobci: Sensata Technologies, Airpax	Dotaz
	Část#: IEG1-34411-2-V Výrobci: Sensata Technologies, Airpax	Dotaz
	Část#: IEG1-34456-2-V Výrobci: Sensata Technologies, Airpax	Dotaz
	Část#: IEG1-34165-R75-V Výrobci: Sensata Technologies, Airpax	Dotaz
	Část#: IEG1-34456-1-V Výrobci: Sensata Technologies, Airpax	Dotaz
	Část#: IEG1-34804-5A-V Výrobci: Sensata Technologies, Airpax	Dotaz
	Část#: IEG1-34804-1-V Výrobci: Sensata Technologies, Airpax	Dotaz
	Část#: IEG1-34804-2A-V Výrobci: Sensata Technologies, Airpax	Dotaz

Související klíčová slova pro IEG1-34804-1A-V

Sensata Technologies, Airpax IEG1-34804-1A-V.	IEG1-34804-1A-V distributor	IEG1-34804-1A-V dodavatel	IEG1-34804-1A-V Cena
IEG1-34804-1A-V Stáhnout datasheet.	IEG1-34804-1A-V Datasheet.	IEG1-34804-1A-V Stock.	koupit IEG1-34804-1A-V.
Sensata Technologies, Airpax IEG1-34804-1A-V.	Sensata Technologies/Airpax IEG1-34804-1A-V.		